

# FICHE D'HOMOLOGATION / HOMOLOGATION FORM



048-TO-08



COMMISSION  
INTERNATIONALE  
DE KARTING - FIA

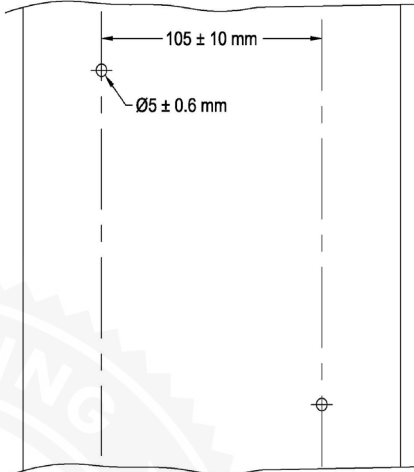

## PNEUMATIQUE / TYRE 5" SLICK OPTION

Manufacturier / <i>Manufacturer</i>	MG INDUSTRIA E COMERCIO S/A
Marque / <i>Make</i>	<b>MG</b>
Modèle / <i>Model</i>	<b>SH2 11x7.10-5</b>
Catégorie / <i>Category</i>	Group 1 & 2
Durée de l'homologation / <i>Validity of the homologation</i>	3 ans / 3 years
Nombre de pages / <i>Number of pages</i>	4
La présente Fiche d'Homologation reproduit descriptions, illustrations et dimensions du pneumatique au moment de l'homologation CIK-FIA et du test d'homologation.	<i>This Homologation Form reproduces descriptions, illustrations and dimensions of the tyre at the moment of the CIK-FIA homologation and of the homologation test.</i>
	
Photo du pneu monté sur la jante / <i>Photo of the tyre fitted to the rim</i>	Dessin de la bande de roulement / <i>Tread design drawing</i>
<b>SIGNATURE ET TAMPON DE L'ASN / SIGNATURE AND STAMP OF THE ASN</b>	<b>SIGNATURE ET TAMPON DE LA CIK-FIA / SIGNATURE AND STAMP OF THE CIK-FIA</b>
	

DESCRIPTIONS TECHNIQUES	TECHNICAL DESCRIPTIONS
Sous une température de 23°C +/-2°C, avec une humidité de 50% +/-5%	At a temperature of 23°C +/-2°C and with a humidity of 50% +/-5%

Pt	Descriptions / Descriptions	Valeurs / Values		Tolérances / Tolerances	
1	Dimensions / <i>Dimensions</i>	11 x 7.10 - 5		--	
2	Désignation du mélange / <i>Tread compound designation</i>	SH2		--	
3	Pression de service / <i>Service pressure</i>	1,1 bar		+/- 0.3 bar	
4	Pression de gonflage / <i>Inflation pressure</i>	4 bar		max	
5	Capacité de charge / <i>Load capacity</i>	100 Kg		max	
6	Vitesse maximale / <i>Maximum speed</i>	185 Km/h			
7	Rigidité latérale et verticale (sous charge de 40 kg) / <i>Lateral and vertical stiffness (under 40 kg load)</i>	L 1 mm V 9 mm		L: +/-1 V: +/-2	
8					
9	Profondeur du profil / <i>Depth of tread</i>	3,5 mm		+/- 0.5 mm	
10	Poids en grammes / <i>Weight in grams</i>	1530 gr		+/- 10%	
11	Nombre de plis / <i>Number of plies</i>	2		--	
12	Épaisseur de la bande de roulement / <i>Tread thickness</i>	3,9 mm		+/- 1.0 mm	
13	Nombre d'indicateurs d'usure du pneu / <i>Number of tread wear indicators</i>	6		--	
14	Matériau de la carcasse / <i>Carcass material</i>	Poliester		--	
15	Angle de tissage de la toile du pneu / <i>Angle of tyre canvas</i>	31,5°		+/- 3°	
16	Type de fil de tissage (selon ISO) / <i>Canvas thread type (according to ISO)</i>	1670		--	
17	Pneu tubeless / <i>Tubeless tyre</i>	YES		--	
18	Dureté superficielle de la bande de roulement (ISO 48:1010 – 2 échantillons de 2 mm d'épaisseur) / <i>Superficial tread hardness (ISO 48:1010 – 2 samples of 2 mm thickness)</i>	53.5		+/- 5 DIDC - IRHD	
19	Contrainte-déformation en traction (ISO 37:2017 – éprouvette type 3) / <i>Tensile stress-strain (ISO 37:2017 – type 3 sample)</i>	à / at 100%	à / at 300%	à / at 100%	à / at 300%
		1.3	5.7	+/- 0.5 MPa	+/- 0.8 MPa

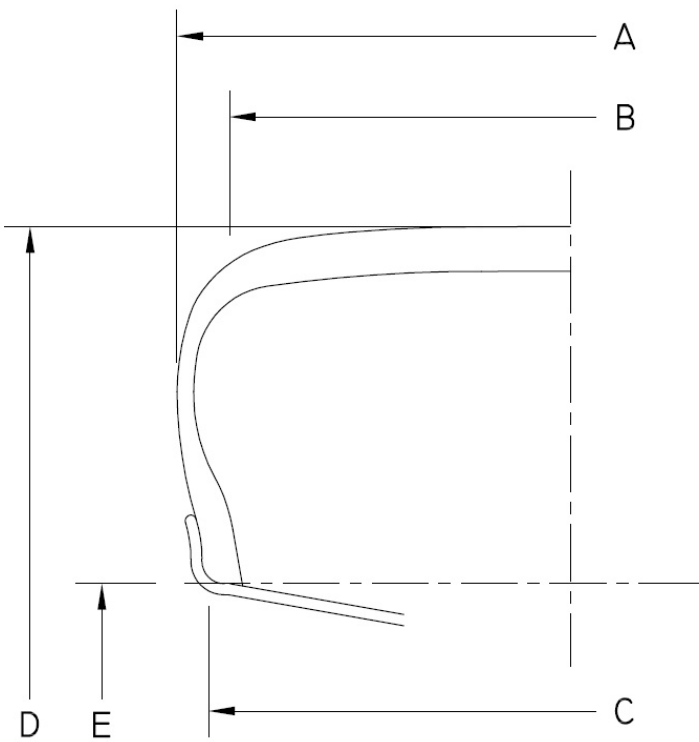

DESSIN

DRAWING

Dessin du pneu en section transversale et dimensions du pneu monté sur une jante / <i>Drawing of tyre cross section and dimensions of the tyre fitted to a rim</i>		Dimensions / <i>Dimensions</i>	Tolérances / <i>Tolerances</i>
		Ø	+/- X
	A	210 mm	± 5 mm
	B	150 mm	± 10 mm
	C	202 mm	± 5 mm
	D	Ø 272 mm	± 10 mm
	E	Ø 126.2 *	+0/-1.0
<p>*Dimension selon Dessin Technique N° 1.1 - Jante 5" / <i>Dimension according to Technical Drawing N° 1.1 - 5" rim</i></p>			

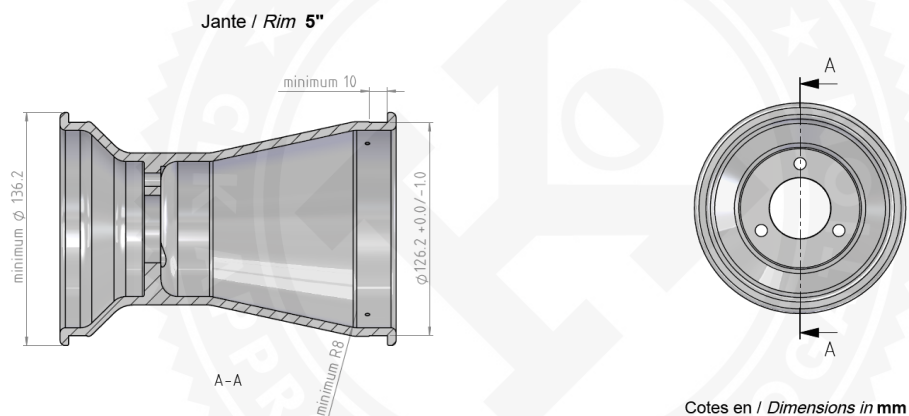
## DESSIN TECHNIQUE N° 1.1 / TECHNICAL DRAWING No. 1.1



PHOTOS ET INSCRIPTIONS	PHOTOS AND INSCRIPTIONS		
Pendant toute la période d'homologation, il est interdit d'apposer des inscriptions autres que celles mentionnées ci-dessous et appliquées lors de la production.	<i>Throughout the homologation period, it is forbidden to affix markings other than those mentioned below and applied at the time of production.</i>		
Photo du flanc extérieur du pneu / <i>Photo of tyre external sidewall</i>	Inscriptions sur le flanc extérieur du pneu / <i>Inscriptions on tyre external sidewall</i>		
	<b>Texte / Text</b>	<b>Hauteur / Height</b>	<b>Trait / Stroke</b>
		mm	mm
	MG (printed)		
	Barcode (printed)		
	KART>>	10,0	3,0
	11 x 7.10 – 5	9,0	2,5
	MAX INFLATION PRESSURE 4 BAR	3,0	0,8
		25x22mm	
Photo du flanc intérieur du pneu / <i>Photo of tyre internal sidewall</i>	Inscriptions sur le flanc intérieur du pneu / <i>Inscriptions on tyre internal sidewall</i>		
	<b>Texte / Text</b>	<b>Hauteur / Height</b>	<b>Trait / Stroke</b>
		mm	mm
	MG	16,0	4,5
	11 x 7.10 – 5	9,0	2,5
	SH2	10,0	2,5
	CIK	5,0	2,0
	OPTION	5,0	1,2
	MADE IN BRAZIL.CNPJ: 93.384.311/0001-82	2,0	1,0
	FOR RACING PURPOSE ONLY - TUBELESS	2,8	1,0
	Barcode (printed)		