



FICHE D'HOMOLOGATION / HOMOLOGATION FORM



COMMISSION
INTERNATIONALE
DE KARTING - FIA

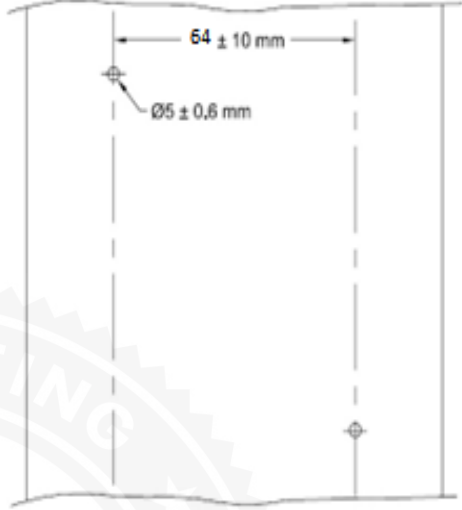

PNEUMATIQUE / TYRE 5" SLICK MINI

Fabricant / <i>Manufacturer</i>	MG INDÚSTRIA E COMÉRCIO S/A
Marque / <i>Make</i>	MG
Modèle / <i>Model</i>	SC2 11x5.00-5
Catégorie / <i>Category</i>	Group 3
Durée de l'homologation / <i>Validity of the homologation</i>	3 ans / 3 years
Nombre de pages / <i>Number of pages</i>	4
La présente Fiche d'Homologation reproduit descriptions, illustrations et dimensions du pneumatique au moment de l'homologation CIK-FIA et du test d'homologation.	<i>This Homologation Form reproduces descriptions, illustrations and dimensions of the tyre at the moment of the CIK-FIA homologation and of the homologation test.</i>
	
Photo du pneu monté sur la jante / <i>Photo of the tyre fitted to the rim</i>	Dessin de la bande de roulement / <i>Tread design drawing</i>
SIGNATURE ET TAMPON DE L'ASN / SIGNATURE AND STAMP OF THE ASN	SIGNATURE ET TAMPON DE LA CIK-FIA / SIGNATURE AND STAMP OF THE CIK-FIA
	

DESCRIPTIONS TECHNIQUES	TECHNICAL DESCRIPTIONS
Sous une température de 23°C +/-2°C, avec une humidité de 50% +/-5%	At a temperature of 23°C +/-2°C and with a humidity of 50% +/-5%

Pt	Descriptions / Descriptions	Valeurs / Values		Tolérances / Tolerances	
1	Dimensions / Dimensions	11 x 5.00 – 5		--	
2	Désignation du mélange / Tread compound designation	SC2		--	
3	Pression de service / Service pressure	1,0 bar		+/- 0.3 bar	
4	Pression de gonflage / Inflation pressure	4 bar		max	
5	Capacité de charge / Load capacity	80 Kg		max	
6	Vitesse maximale / Maximum speed	150 Km/h			
7	Rigidité latérale et verticale (sous charge de 40 kg) / Lateral and vertical stiffness (under 40 kg load)	L 1 mm V 11,5 mm		L: +/-1 V: +/-2	
8					
9	Profondeur du profil / Depth of tread	3,5 mm		+/- 0.5 mm	
10	Poids en grammes / Weight in grams	1145 gr		+/- 10%	
11	Nombre de plis / Number of plies	2		--	
12	Épaisseur de la bande de roulement / Tread thickness	4,0 mm		+/- 1.0 mm	
13	Nombre d'indicateurs d'usure du pneu / Number of tread wear indicators	6		--	
14	Matériau de la carcasse / Carcass material	Poliester		--	
15	Angle de tissage de la toile du pneu / Angle of tyre canvas	32,5°		+/- 3°	
16	Type de fil de tissage (selon ISO) / Canvas thread type (according to ISO)	1100		--	
17	Pneu tubeless / Tubeless tyre	YES		--	
18	Dureté superficielle de la bande de roulement (ISO 48:1010 – 2 échantillons de 2 mm d'épaisseur) / Superficial tread hardness (ISO 48:1010 – 2 samples of 2 mm thickness)	50.4		+/- 5 DIDC - IRHD	
19	Contrainte-déformation en traction (ISO 37:2017 – éprouvette type 3) / Tensile stress-strain (ISO 37:2017 – type 3 sample)	à / at 100%	à / at 300%	à / at 100%	à / at 300%
		1.6	7.5	+/- 0.5 MPa	+/- 0.8 MPa
20	Largeur de la bande / Tread width	74.0		Arrière / Rear: max. 120 mm	



DESSIN

DRAWING

Dessin du pneu en section transversale et dimensions du pneu monté sur une jante / <i>Drawing of tyre cross section and dimensions of the tyre fitted to a rim</i>		Dimensions / <i>Dimensions</i>	Tolérances / <i>Tolerances</i>
		Ø	+/- X
	A	145 mm	± 5 mm
	B	110 mm	± 10 mm
	C	134 mm	± 3 mm
	D	Ø 264	± 10 mm
	E	Ø 126.2 *	+0/-1.0
	*Dimension selon Dessin Technique N° 1.1 - Jante 5" / <i>Dimension according to Technical Drawing N° 1.1 - 5" rim</i>		

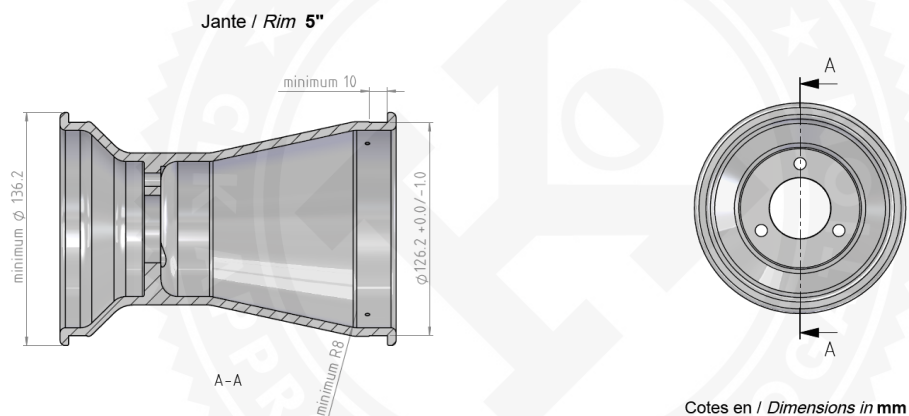
DESSIN TECHNIQUE N° 1.1 / TECHNICAL DRAWING No. 1.1



PHOTOS ET INSCRIPTIONS	PHOTOS AND INSCRIPTIONS		
<p>Pendant toute la période d'homologation, il est interdit d'apposer des inscriptions autres que celles mentionnées ci-dessous et appliquées lors de la production.</p>	<p><i>Throughout the homologation period, it is forbidden to affix markings other than those mentioned below and applied at the time of production.</i></p>		
<p>Photo du flanc extérieur du pneu / <i>Photo of tyre external sidewall</i></p>	<p>Inscriptions sur le flanc extérieur du pneu / <i>Inscriptions on tyre external sidewall</i></p>		
	<p>Texte / Text</p>	<p>Hauteur / Height</p>	<p>Trait / Stroke</p>
		<p>mm</p>	<p>mm</p>
	<p>MG (printed)</p>		
	<p>Barcode (printed)</p>		
	<p>KART>></p>	<p>10,0</p>	<p>2,5</p>
	<p>11 x 5.00 – 5</p>	<p>8,0</p>	<p>2,5</p>
	<p>MAX INFLATION PRESSURE 4 BAR</p>	<p>3,0</p>	<p>1,0</p>
	<p></p>	<p>22x22mm</p>	
<p>Photo du flanc intérieur du pneu / <i>Photo of tyre internal sidewall</i></p>	<p>Inscriptions sur le flanc intérieur du pneu / <i>Inscriptions on tyre internal sidewall</i></p>		
	<p>Texte / Text</p>	<p>Hauteur / Height</p>	<p>Trait / Stroke</p>
		<p>mm</p>	<p>mm</p>
	<p>MG</p>	<p>16,0</p>	<p>4,5</p>
	<p>11 x 5.00 – 5</p>	<p>8,0</p>	<p>2,5</p>
	<p>SC2</p>	<p>10,0</p>	<p>2,8</p>
	<p>CIK</p>	<p>5,0</p>	<p>2,0</p>
	<p>MINI</p>	<p>5,0</p>	<p>1,0</p>
	<p>MADE IN BRAZIL.CNPJ: 93.384.311/0001-82</p>	<p>2,0</p>	<p>1,0</p>
	<p>FOR RACING PURPOSE ONLY - TUBELESS</p>	<p>2,8</p>	<p>1,0</p>
<p>Barcode (printed)</p>			